

# 4LTA G2I100

## Pyroelectric Four Channel Detector for measurement application

<b>Element size</b>	2 mm × 2 mm
<b>Aperture</b>	3.0 mm
<b>Filter<sup>1</sup></b>	custom-designed
<b>Responsivity<sup>2,3</sup></b>	> 70000 V/W
<b>Noise<sup>2</sup></b>	< 20000 nV/√Hz
<b>Specific detectivity<sup>2,3</sup></b>	2.5·10 <sup>8</sup> cm√Hz/W
<b>Offset voltage</b>	<5 mV
<b>Operating voltage</b>	±2.2 V to ±8 V
<b>Housing</b>	TO 8
<b>Operating temperature</b>	-20 to 70 °C
<b>Storage temperature</b>	-20 to 70 °C

<sup>1</sup> Other filters on request. <sup>2</sup> Frequency: 10 Hz, ambient temperature: 25 °C.

<sup>3</sup> Black body source temperature: 500 K, Filter transmission: 100 %.

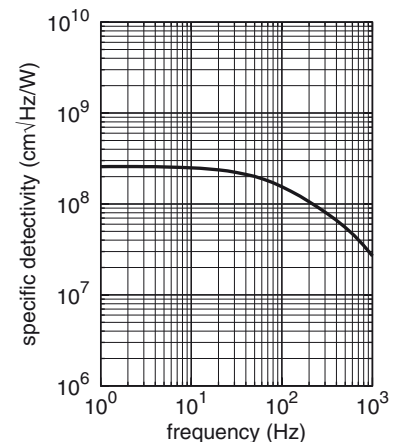
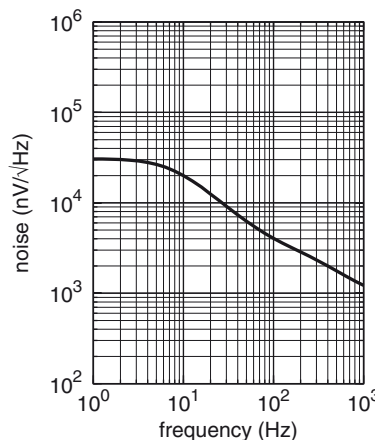
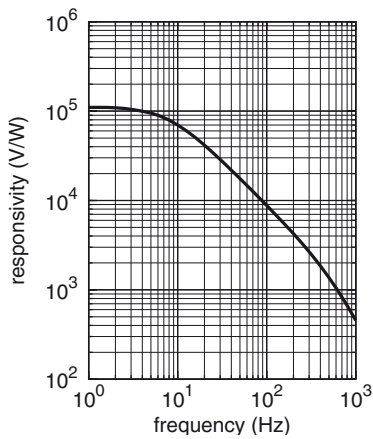
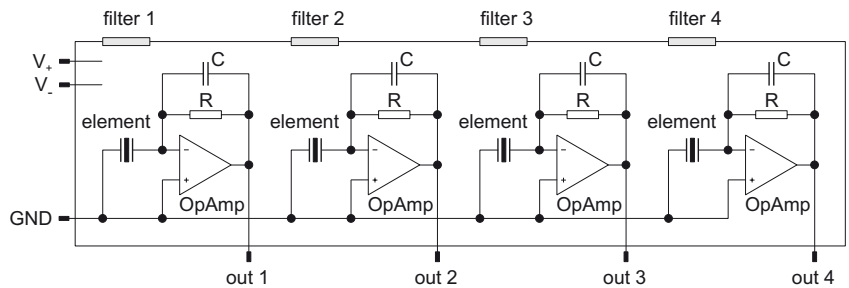
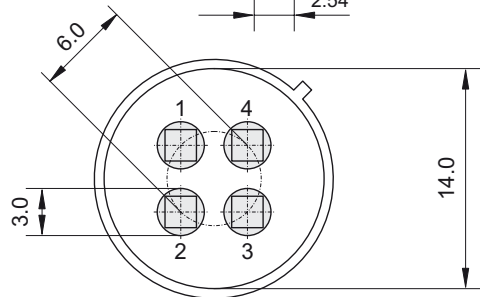
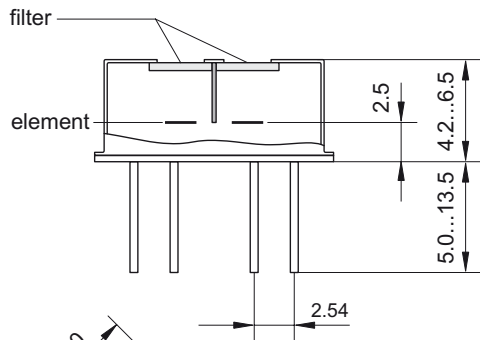
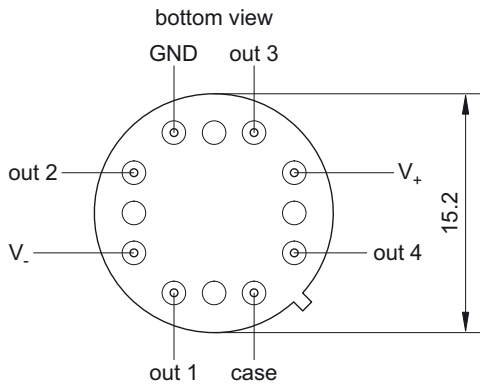

Technische Änderungen vorbehalten. Technical details are subject to change. 24.06.19



Phone: +49 351 896 74-0  
 Fax: +49 351 896 74-99  
 Email: info@dias-infrared.de  
 Internet: www.dias-infrared.com

DIAS Infrared GmbH  
 Pforzheimer Straße 21  
 01189 Dresden  
 Germany