

4LTA G2PC

Pyroelectric Four Channel Detector for measurement application

Element size	2 mm × 2 mm
Aperture	3.0 mm
Filter¹	custom-designed
Responsivity^{2,3}	> 150 V/W
Noise²	< 100 nV/√Hz
Specific detectivity^{2,3}	3·10 ⁸ cm√Hz/W
Thermal compensation	parallel
Offset voltage	0.4 to 1.5 V
Operating voltage	2 V to 18 V
Housing	TO 8
Operating temperature	-20 to 70 °C
Storage temperature	-20 to 70 °C

¹ Other filters on request. ² Frequency: 10 Hz, ambient temperature: 25 °C.

³ Black body source temperature: 500 K, Filter transmission: 100 %.

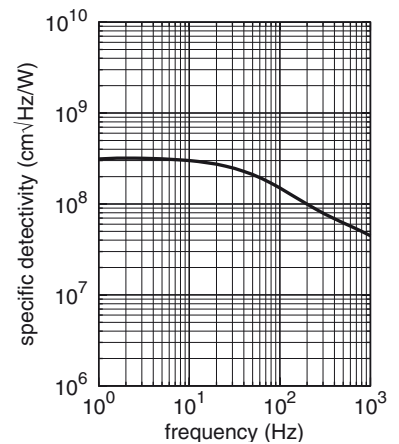
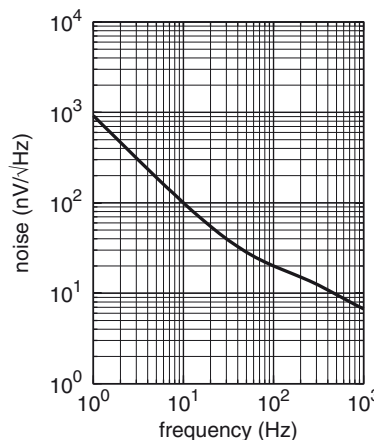
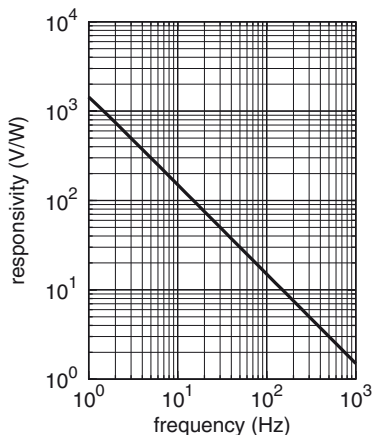
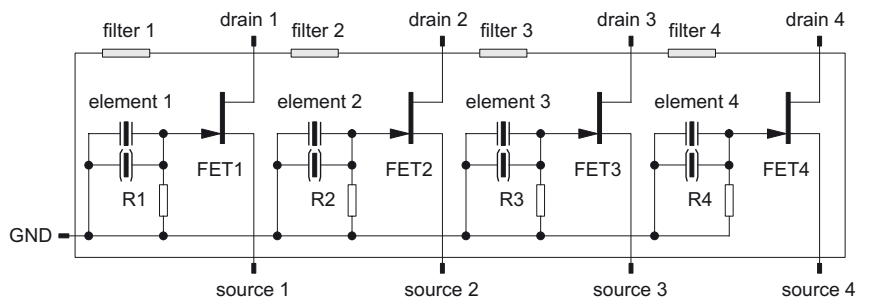
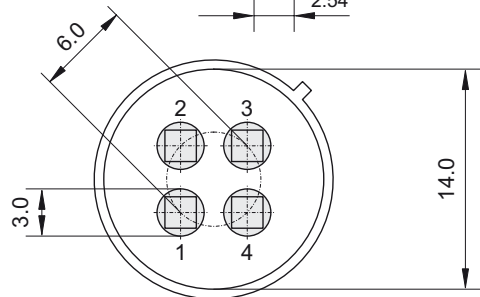
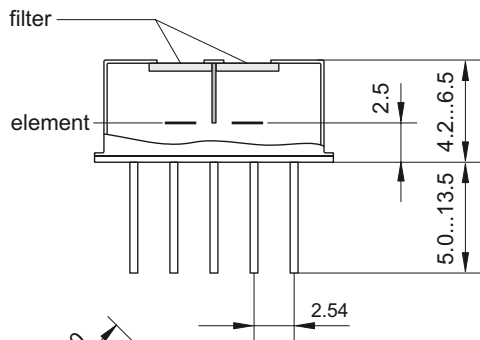
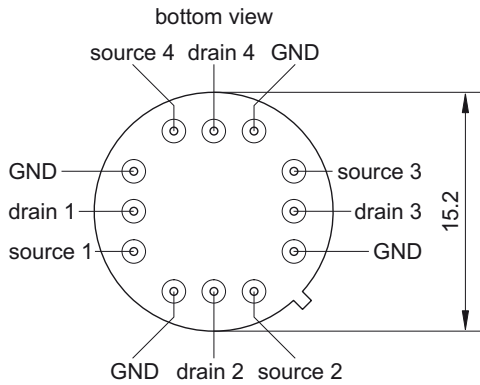

Technische Änderungen vorbehalten. Technical details are subject to change. 24.06.19



Phone: +49 351 896 74-0
 Fax: +49 351 896 74-99
 Email: info@dias-infrared.de
 Internet: www.dias-infrared.com

DIAS Infrared GmbH
 Pforzheimer Straße 21
 01189 Dresden
 Germany