

LTS Q1

Pyroelectric Single Element Detector for measurement application

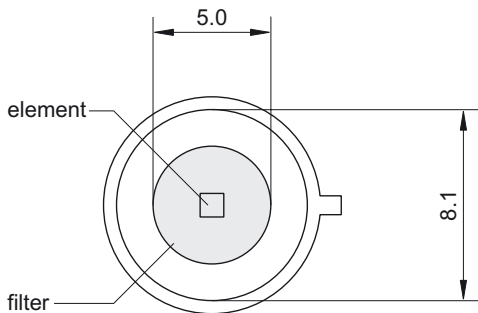
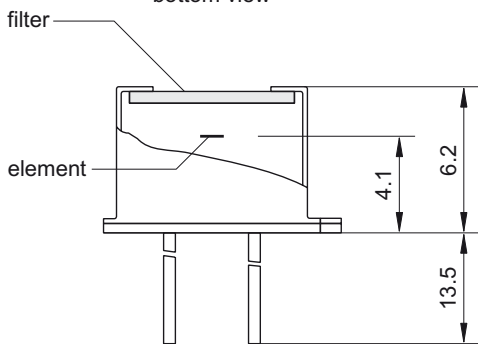
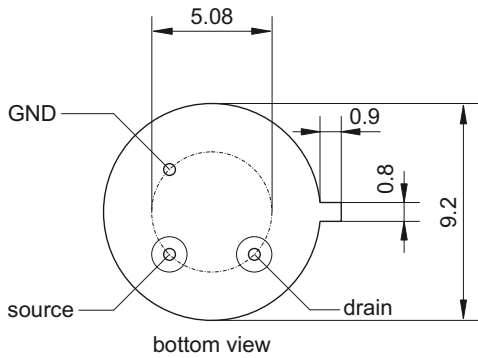

Element size	1 mm × 1 mm
Aperture	5.0 mm
Filter¹	custom-designed
Responsivity^{2,3}	> 1600 V/W
Noise²	< 500 nV/√Hz
Specific detectivity^{2,3}	3·10 ⁸ cm√Hz/W
Offset voltage	0.4 to 1.5 V
Operating voltage	2 V to 18 V
Housing	TO 39
Operating temperature	-20 to 60 °C
Storage temperature	-20 to 60 °C

¹ Other filters on request. ² Frequency: 10 Hz, ambient temperature: 25 °C.

³ Black body source temperature: 500 K, Filter transmission: 100 %.

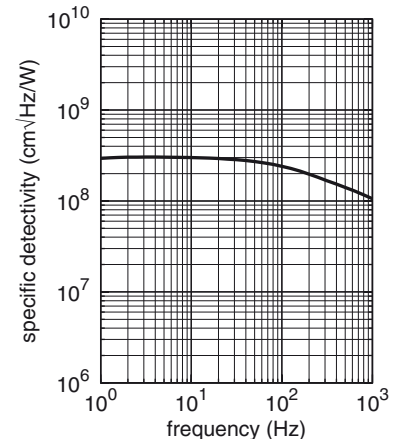
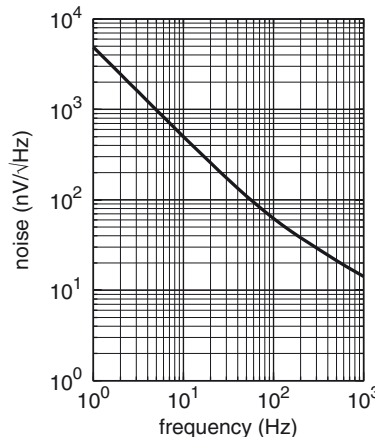
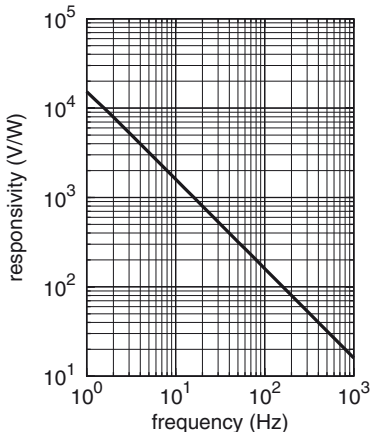
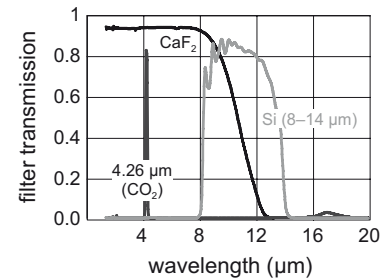
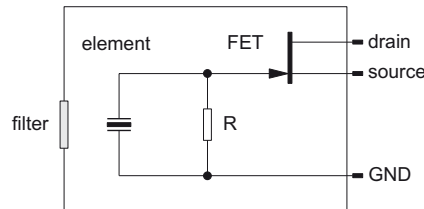

Technische Änderungen vorbehalten. Technical details are subject to change. 24.06.19



Phone: +49 351 896 74-0
 Fax: +49 351 896 74-99
 Email: info@dias-infrared.de
 Internet: www.dias-infrared.com

DIAS Infrared GmbH
 Pforzheimer Straße 21
 01189 Dresden
 Germany